

# JULIET



## SMART TOP

The JULIET series is a new Pole Top with Symmetric direct Architectural Garden, Park or Street Lighting Series in Power LED Version providing precision optical system which gives very low glare rating, while reducing light pollution. It can achieve the desired effect in a wide range of applications with high quality optical systems and for direct lighting. JULIET series are designed to offer functional, a wide range of lighting solution and dramatic highlighting through the design with super finishing as well highest efficiency with long service life. This product provide soft, uniform, enhancing special lighting effect that blends into the space being lit, to maximizes light beauty. Designed to illuminate Parks, Garden, Streets, Urban Centers, Squares, Pedestrian and more.

The housing materials of the fixture of this series can be specified as main structure made of heavy duty Die cast aluminum covered by anti-corrosion resistant covering 5 years of warranty.

The JULIET series is equipped with a uniquely designed for better protection and durability, easier installation and maintenance.



### Description

350mA/500mA/750mA/1050mA

Body:	Heavy Duty Die-cast aluminium.
Optical system:	Adopt modular light distribution lens, diffuser with super white, UV Resistant and Antiglare tempered Flat glass lens diffuser.
LED	Highest quality LEDs. Maintaining a 3-Step MacAdam ellipse one bin only, creating perfect LED color consistency.
LED Life	50,000 Hrs or more based on Climate / Ambient Temperature
Gear plate:	Galvanized steel plate, button design for opened device. Built in Electronics Driver (Meanwell / OSRAM / Tridonic Atco / Philips / Inventronics / Eagle, etc. Durable Silicon Rubber Gasket. 3000/4000/6000K CCT. Excellent heat dissipation. Color Rendering Index is 80+.
luminaire control:	Quick on/off connector when be open.
Finishing:	Surface anti-ageing electrostatic spray processing, super resistance to corrosion and chemical protection.
Assembling height:	4-6 m.
Fixing:	Top or side fitting Ø60mm, angle can be adjustable.
Operating Temperature	-30°C to 50°

**PHILIPS**  
LUMILEDS



# JULIET

## SMART TOP

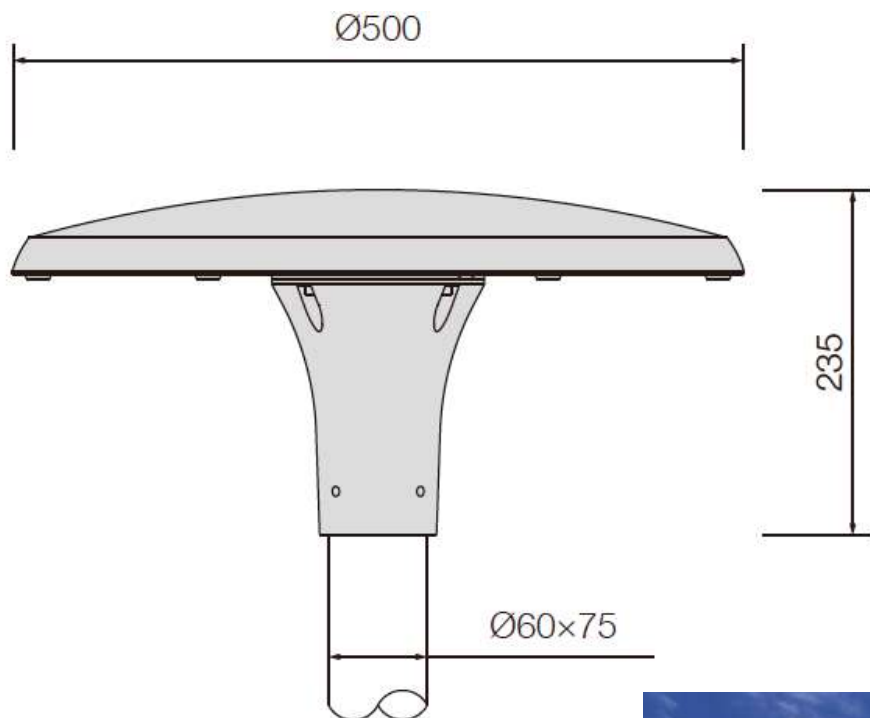

Due to continuous improvements, specifications may change without prior notice.



# JULIET

## SMART TOP



### Optical Application

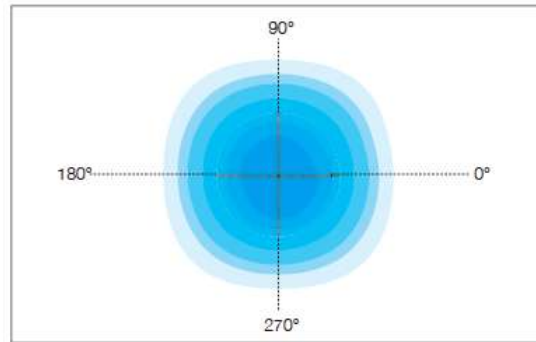
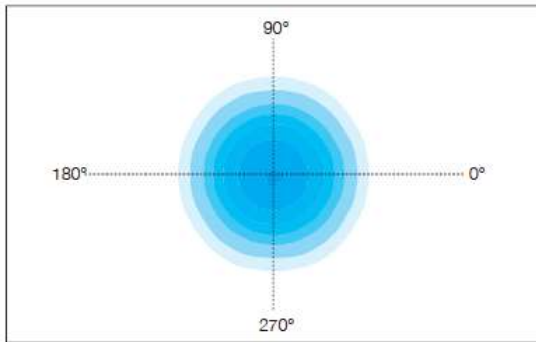
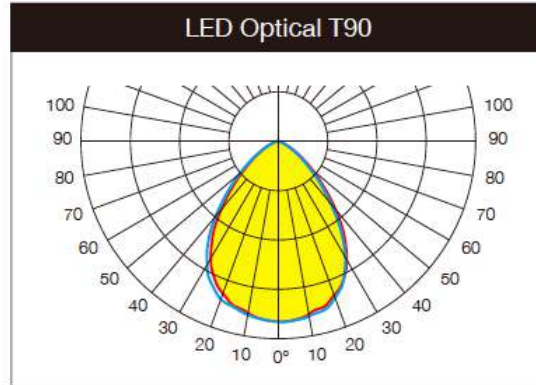
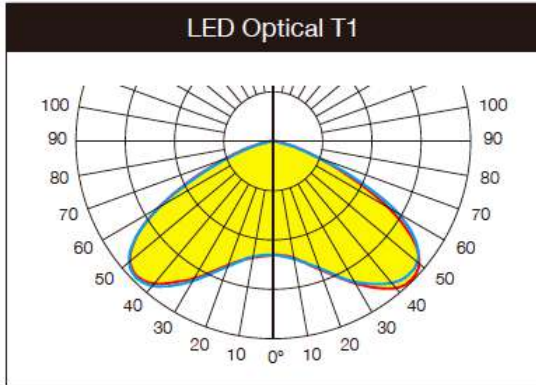









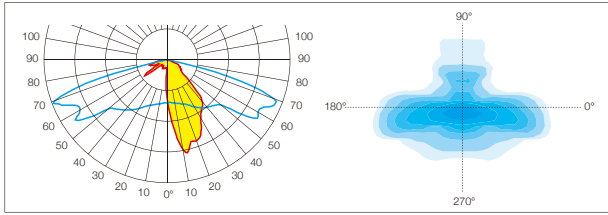

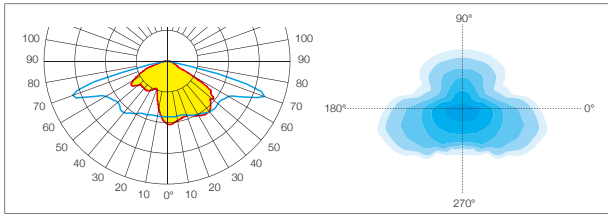
#### Technology Data

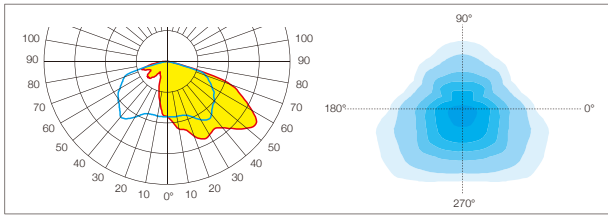
Code	Lamp	Watt	LED Pcs	lumens	LED
JULIET	LED	40W	32 / 112	75-98 Lumens @ Watt	<b>PHILIPS</b> <b>LUMILEDS</b> <b>CREE</b>
		60W	32	3000K   4000K   5000K   6000K	

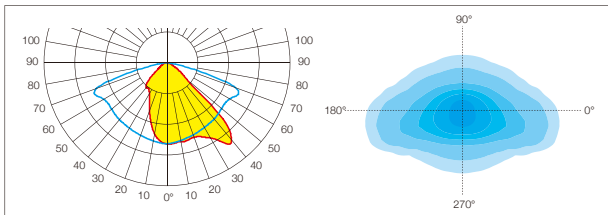

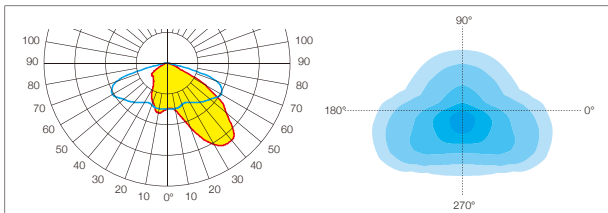
# Lens Application

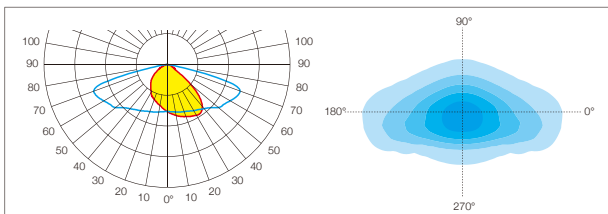
Reference	Destination	Light Distribution	Application
T2A			Asymtric light distribution for Narrow road. LED Chips: 2x2
T3A			Asymtric light distribution for Residential street. LED Chips: 2x2
T4A			Asymtric light distribution for wide area. LED Chips: 2x2
T3			Asymtric light distribution for urban road. LED Chips: 2x2
T4			Asymtric light distribution for motorway road. LED Chips: 2x2
T5			Asymtric light distribution for urban road. LED Chips: 1x15



Reference

Destination

Light Distribution

Application

T12

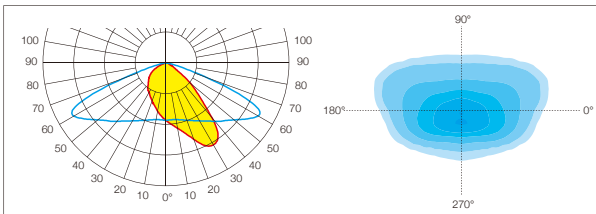
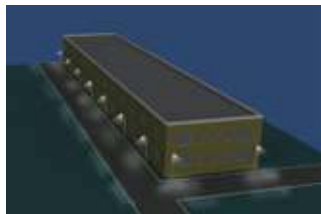

Asymtric light distribution for Residential street.

LED Chips: 1x1

T13

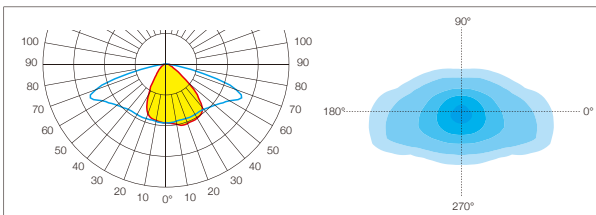

Asymtric light distribution for urban road.

LED Chips: 1x1

T14

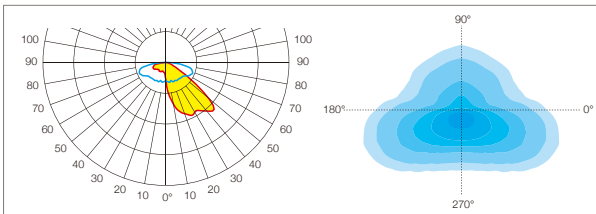
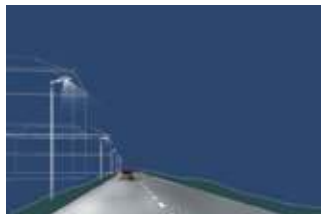

Asymtric light distribution for middle area.

LED Chips: 1x1

T1

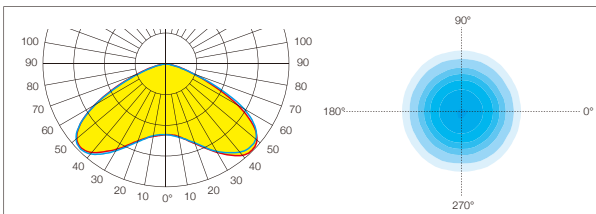

Symtric light distribution for square, park, highbay lighting.

LED Chips: 2x2

T25

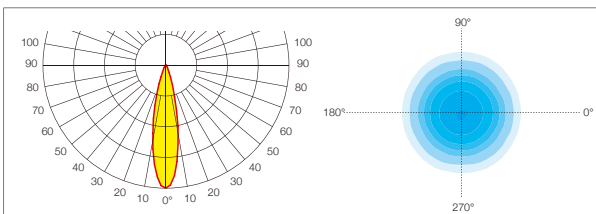

Symtric light distribution for narrow angle flood, highbay lighting.

LED Chips: 2x2

T60

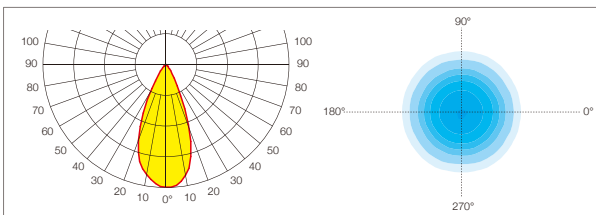

Symtric light distribution for middle angle flood, highbay lighting.

LED Chips: 2x2

